

Knürr Smaract®



# Knürr Smaract®

19" Compact Rack

19" Server Compact Rack 1.76 to 1.90

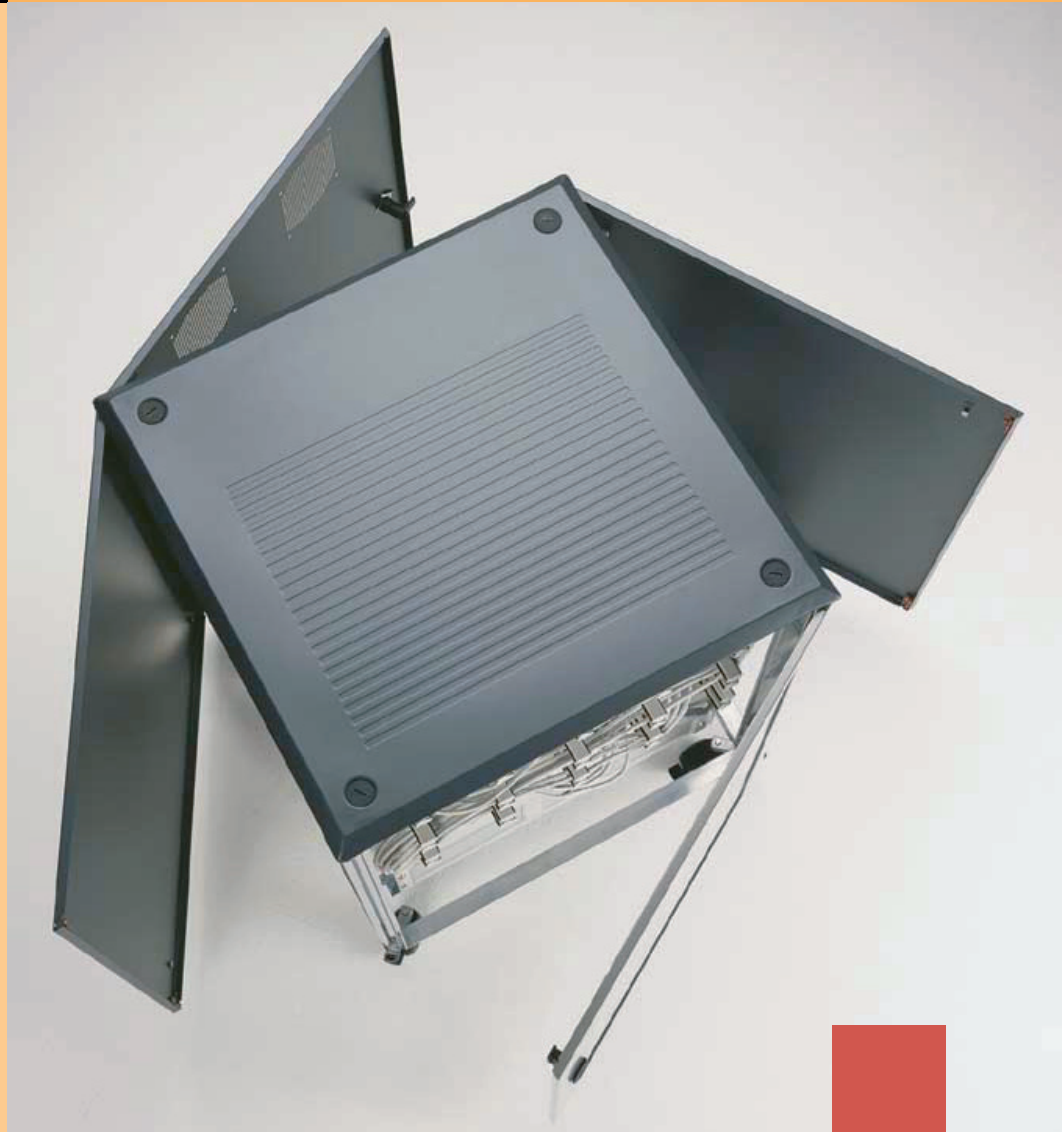

## Network and Server Compact Rack

Knürr Smaract®  
Strong points 1.78

Knürr Smaract®  
19" Compact Rack 1.80

Knürr Smaract®  
19" Server Compact Rack 1.81

Knürr Smaract®  
19" Compact Rack  
Without Door 1.82

Knürr Smaract®  
Accessories

- Ventilation unit 1.83
- Extrusions 1.83
- Depth Brace 1.84
- Rear Door 1.84
- Top Cover/Bottom Cover 1.84
- Filter Mat 1.85
- Plinth 1.85
- Swivel Castors 1.85

- Stacking Set 1.86
- Eyebolt Set 1.86
- Wall Mounting Bracket 1.86

Knürr Smaract®  
19" Compact Rack EMC 1.87

Knürr Smaract®  
19" Compact Rack IP54 1.89

# Knürr Smaract®



The Knürr **Smaract**® Compact Rack isn't just a further development of the LAN racks that we already know and that have been proven in use for some time now; it is, in fact, more of a specific response to the requirement for decentralized networking in the company.

**Smaract**® stands for an innovative and practical total concept with extremely low spatial demands. High-grade flexibility and especially high performance! At the same time it is also integration-enabled, can be modularly expanded at any time and is rich in impressive detailed solutions.

An ideal 19" compact construction platform in various models that meet IP and EMC requirements.



## Features

- Not a single cubic centimeter is wasted with the Smaract® Compact Rack. The innovative frame concept with triangular extrusions keeps weight low and stability high.
- The patented mounting hole rails in the 19" extrusion ensure all installed active and passive components can be quickly and easily positioned.
- The Knürr Smaract® doors and side panels can be opened with an angle of over 180°, and the side panels can be removed in seconds with the special system used.
- The Smaract® 19" Compact Rack is available in EMC and IP versions. Special attention was paid during the development phase to ensuring that this server and network rack remains constantly upgradeable to IP or EMC standards.
- A cost-effective solution can also be supplied in a combined IP-EMC version.

## Benefits

- Access from all sides is a central element of the rack's design. Massive time savings with system integration and component maintenance.
- The Smaract® Compact Rack can be modularly set up and stacked, and is therefore predestined for system integration. The new 900 mm depth in the stacked version makes the Smaract® especially popular with Internet solution providers.
- The central locking guarantees controlled access. Additionally, the side covers can only be removed when the front doors have been opened. Special lock systems, e.g. with chip card reader or keypad can also be selected on request.
- The 19" Compact Rack is available in 9 U, 15 U and 21 U versions, and in sizes 12 U (home office) and 18 U. The 900 mm installation depth is available for server applications.



Innovative frame concept:  
Low weight – high stability

## Design with Class

Function simply isn't everything! The Knürr® Compact Rack sets new standards in design matters. The basic purpose of the design concept is to translate the extended technical value creation into an appropriate but unobtrusive overall presence. This new Smaract® Compact Rack, developed in cooperation with designafairs, displays its exceptional technical features on the outside, with eye-catching stability and simplicity.

## Knürr Smaract® Strong points

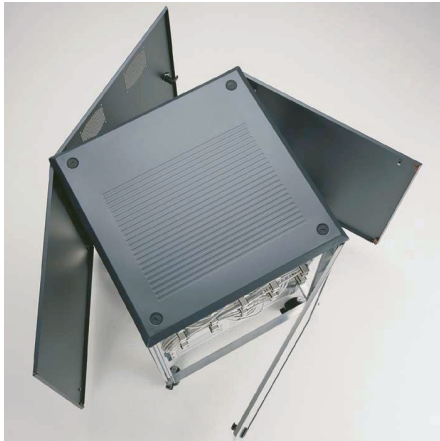

1 SMA20006

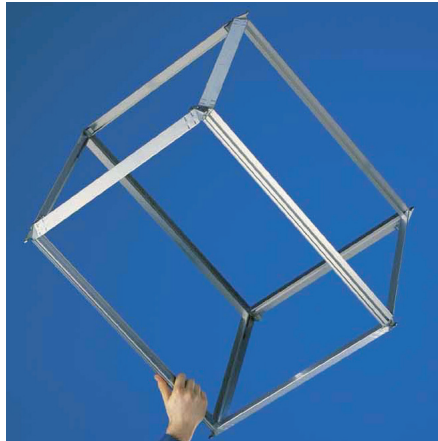

2 SMA20005



3 SMA20004



4 SMA20056

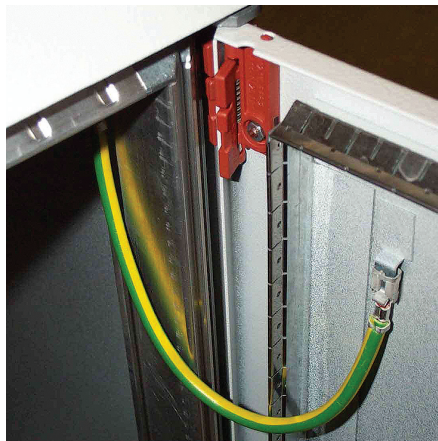

5 SMA20046

### 1 Access

Access from all sides is a time-saving factor, e.g. with system integration or maintenance.

### 2 Intelligent construction

Low weight with innovative frame concept – nevertheless, high stability with new triangular extrusions.

### 3 Evolving with the task

Simple expansion with stackability.

### 4 Cable management

No matter how complex, Knürr provides solutions.

### 5 EMC and IP version

The compact rack can be upgraded to IP or EMC standard at all times. (Also in combined IP/EMC version)

### 6 Forward-thinking

Flexibility with integration of 19" technology. 6 heights to choose from; 9 U to 24 U.



6 SMA20017





SMA20067

## Knürr Smaract® 19" Rack in acc. with IEC 297 Technical data

### Material

- Extruded aluminum
- Corner connector, die-cast
- Sheet steel covers
- Doors: sheet steel or with single safety glass panel, opening angle, over 180°

### Finish:

- Basic rack, polished
- Covers, powder-coated texture, RAL 7035 light gray

### Static load rating

- 2000 N with stationary version

### 19" components in acc. with IEC 297-3

- Height: 9 U to 24 U; 1 U = 44.45 mm
- Width: 482.6 mm (19")

### How supplied

- Fully assembled

### Tests according to version

- Safety in acc. with EN 50298 and EN 60950
- Protective conductor/ earth in acc. with DIN VDE 0701-1
- Vibration test in acc. with MIL-STD 810 E
- Vibration and shock test in acc. with DIN EN 300019-2-2
- IP test in acc. with DIN EN 60529
- EMC shielding attenuation in acc. with IEEE-STD-299 and VG 95 373 part 15 (30 MHz - 1 GHz)
- Plastic components in compliance with UL 94-V0

### Versions

- IP 20
- IP 54
- EMC

### Space solution

- 82% of the basic surface can be used as space for installation and cable routing

### Configuration

- Stationary, on leveling feet
- Mobile on castors with snib



SMA20166



SMA20109



SMA20122



SMA20024

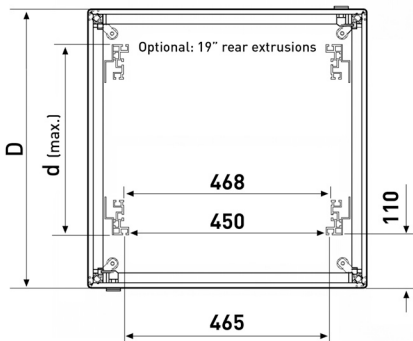
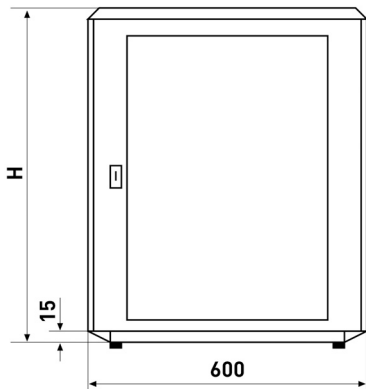

SMA20026

## Knürr Smaract® 19" Compact Rack With glass door

- For components in acc. with IEC 297-3
- Access from all sides, removable covers
- Flexible assembly of the components using T-slot (also optional with mounting holes)
- Cable entry via rear panel (also optionally via top cover/bottom cover)
- Heat loss discharge via own convection or with fan unit on the rear panel (accessory)
- Door opening angle, 180°
- Front door with single safety glass panel, lockable

**Jumping space**  
At the front: 110 mm

**Load rating**  
2000 N static

**Protection rating**  
IP 20

**Material/Finish**

- Basic rack, extruded aluminum, polished
- Corner connector, die-cast, polished
- Covers, sheet steel, powder-coated texture
- Glass infill front door, single safety glass panel

**Color**  
RAL 7035 light gray

**Supply schedule**

- 1 basic rack
- 2 side panels, closed, hinged on both sides
- 1 top cover, closed
- 1 glass front door, lockable
- 1 rear door with cable entry, lockable, prepared for ventilation unit
- 2 19" aluminum vertical extrusions, front, with T-slot and increment slide for spring nut M5 or 19" sheet steel vertical extrusion, front (see table)
- 1 earthing set
- 4 leveling feet

**How supplied**  
Assembled

**Note**

If required, please also order 19" extrusions (see page 1.83) for rear 19" level

W	H	D	U	h	d(max.)	kg	Model	Order no.	
<b>UP</b>									
600	478	600	9	450	16	16	With 19" T-slot extru.	02.110.007.1	1 unit
600	612	600	12	450	20	20	With 19" T-slot extru.	02.110.012.1	1 unit
600	745	600	15	450	24	24	With 19" T-slot extru.	02.110.017.1	1 unit
600	879	600	18	450	28	28	With 19" T-slot extru.	02.110.022.1	1 unit
600	1012	600	21	450	32	32	With 19" T-slot extru.	02.110.027.1	1 unit
600	1143	600	24	450	36	36	With 19" T-slot extru.	02.110.032.1	1 unit
600	478	800	9	650	19	19	With 19" T-slot extru.	02.110.009.1	1 unit
600	612	800	12	650	23	23	With 19" T-slot extru.	02.110.014.1	1 unit
600	745	800	15	650	27	27	With 19" T-slot extru.	02.110.019.1	1 unit
600	879	800	18	650	31	31	With 19" T-slot extru.	02.110.024.1	1 unit
600	1012	800	21	650	35	35	With 19" T-slot extru.	02.110.029.1	1 unit
600	1145	800	24	650	39	39	With 19" T-slot extru.	02.110.034.1	1 unit
600	478	600	9	450	16	16	With 19" mounting hole extru.	02.110.057.1	1 unit
600	612	600	12	450	20	20	With 19" mounting hole extru.	02.110.062.1	1 unit
600	745	600	15	450	24	24	With 19" mounting hole extru.	02.110.067.1	1 unit
600	879	600	18	450	28	28	With 19" mounting hole extru.	02.110.072.1	1 unit
600	1012	600	21	450	32	32	With 19" mounting hole extru.	02.110.077.1	1 unit
600	1145	600	24	450	36	36	With 19" mounting hole extru.	02.110.082.1	1 unit
600	478	800	9	650	19	19	With 19" mounting hole extru.	02.110.059.1	1 unit
600	612	800	12	650	23	23	With 19" mounting hole extru.	02.110.064.1	1 unit
600	745	800	15	650	27	27	With 19" mounting hole extru.	02.110.069.1	1 unit
600	879	800	18	650	31	31	With 19" mounting hole extru.	02.110.074.1	1 unit
600	1012	800	21	650	35	35	With 19" mounting hole extru.	02.110.079.1	1 unit
600	1145	800	24	650	39	39	With 19" mounting hole extru.	02.110.084.1	1 unit

**Dimensions in mm:** W = Width, H = Height, D = Depth, h = installation height, d = useful depth, L = length, U = standard height unit, 1U = 44.45 mm, UP = unit of packaging, kg = weight, = Express item

**Conversion:** 1 mm = 0.03937 inch, 1 kg = 2.2046 pound





SMA20067

## Knürr Smaract® 19" Server Compact Rack With perforated door

- For components in acc. with IEC 297-3
- Access from all sides, removable covers
- With special 19" server extrusions for mounting trade standard servers
- With perforated doors on the front and rear (hexagonal perforation with high flow cross-section) for optimal airflow
- Door opening angle, 180°

### ■ Jumping space

At the front: 75 mm

### ■ Airflow circulation

1.150 cm<sup>2</sup> with 9 U  
1.950 cm<sup>2</sup> with 15 U  
2.700 cm<sup>2</sup> with 21 U  
3.100 cm<sup>2</sup> with 24 U

### ■ Material/Finish

- Basic rack, extruded aluminum, polished
- Corner connector, die-cast, polished
- Covers, sheet steel, powder-coated texture

### ■ Color

Final digit of order number .1:  
RAL 7035 light gray  
Final digit of order number .8:  
RAL 7021 dark gray

### ■ Supply schedule

1 basic rack  
2 side panels, closed, hinged on both sides  
1 top cover, closed  
1 front door with perforation, lockable  
1 rear door with perforation, lockable  
4 19" server sheet steel mounting hole extrusions  
1 earthing set  
4 leveling feet

### ■ Note

Also order mounting adapters for 19" server extrusion for mounting Knürr accessories. Set with 4 adapters 01.127.119.9

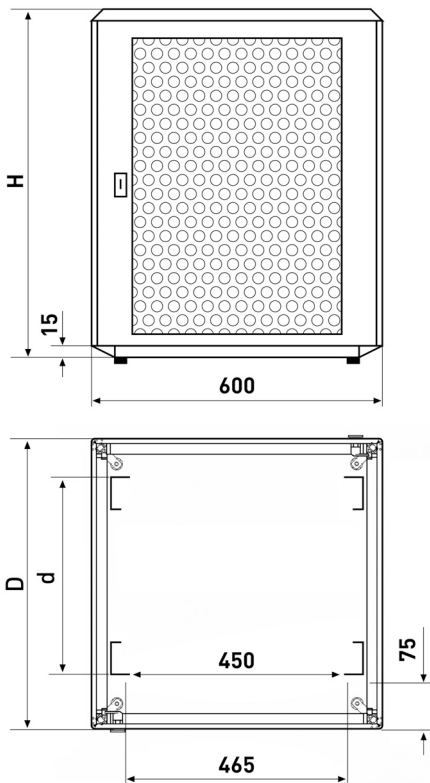

SMA20060

W	H	D	U	h	d	kg	Design	Order no.	UP
600	478	900	9	740	21		Door without frame	02.110.010.1	1 unit
600	478	900	9	740	21		Door without frame	02.110.010.8	1 unit
600	745	900	15	740	29		Door with frame	02.110.020.1	1 unit
600	745	900	15	740	29		Door with frame	02.110.020.8	1 unit
600	1012	900	21	740	37		Door with frame	02.110.030.1	1 unit
600	1012	900	21	740	37		Door with frame	02.110.030.8	1 unit
600	1145	900	24	740	41		Door with frame	02.110.035.1	1 unit
600	1145	900	24	740	41		Door with frame	02.110.035.8	1 unit
600	1145	1000	24	740	43		Door with frame	02.110.040.1	1 unit
600	1145	1000	24	740	43		Door with frame	02.110.040.8	1 unit



SMA20025

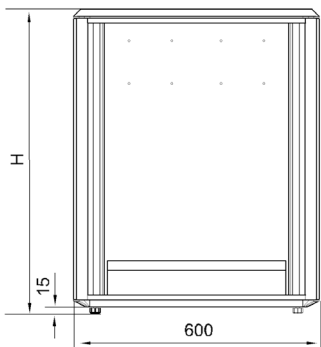

SMA20027

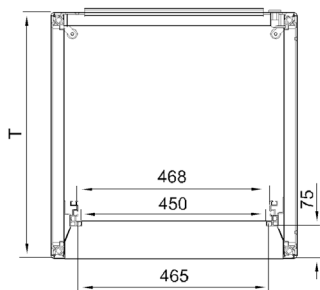

SMA20042

## Knürr Smaract® 19" Compact Rack Enclosure without door

- For components in acc. with IEC 297-3- Removable covers

■ **Load rating**

- 2000 N static

■ **Material/Finish**

- Basic rack, extruded aluminum, polished  
 - Corner connector, die-cast, polished  
 - Covers, sheet steel, powder-coated texture

■ **Color**

- RAL 7035 light gray

■ **Supply schedule**



1 basic rack  
 2 side panels, closed, hinged on both sides  
 1 top cover, closed  
 1 trim frame, front  
 1 rear door with cable entry, lockable, prepared for ventilation unit  
 2 19" aluminum vertical extrusions, front, with T-slot  
 1 earthing set  
 4 leveling feet

■ **How supplied**

- Assembled

■ **Note**

If required, please also order 19" extrusions (see page 1.83) for rear 19" level

W	H	D	U	h	d	kg	Model	Order no.	UP
600	478	600	9			16		02.110.107.1	1 unit
600	745	600	15			24		02.110.117.1	1 unit 
600	1012	600	21			28		02.110.127.1	1
unit									
600	478	800	9			19		02.110.109.1	1 unit 
600	745	800	15			25		02.110.119.1	1 unit
600	1012	800	21			31		02.110.129.1	1 unit

**Dimensions in mm:** W = Width U = standard height unit  
 H = Height 1 U = 44.45 mm  
 D = Depth UP = unit of packaging  
 h = installation height kg = weight  
 d = useful depth  = Express item  
 L = length

**Conversion:** 1 mm = 0.03937 inch 1 kg = 2.2046 pound





SMA20176

### Knürr Smaract® Ventilation Unit

- Easy add-on on the rear panel  
With two axial fans
- With thermostat
- Available in two different performance classes

#### ■ Single fan technical data

- Type 1  
Max. volume flow (free blowing):  
177.17 yd³/h  
Noise (free blowing): 37 dB(A)
- Type 2 (quiet):  
Max. volume flow (free blowing):  
120 m³/h  
Noise (free blowing): 32 dB(A)

#### ■ Technical data, thermostat

- Setting range: 0 to 60 °C
- Mains supply: 240 V/50Hz
- Nominal current: 16 A

#### ■ Material/Finish

Sheet steel, zinc-passivated

#### ■ Supply schedule

1 fan unit wired ready for connection,  
with thermostat  
Mounting material

#### ■ How supplied

Preassembled



SMA20180

W	H	D	U	d	kg	Model	Order no.	UP
						Type 1	02.111.180.9	1 unit
						Type 2 (quiet)	02.111.181.9	1 unit

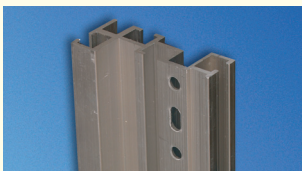

SMA20103

### Knürr Smaract® 19" aluminum extrusion with T-slot

- For front and rear installation

#### ■ Material/Finish

19" extrusions: Extruded aluminum,  
polished  
Mounting bracket: Sheet steel, zinc-  
passivated

#### ■ Supply schedule

2 19" extrusions with T-slot incl. increment  
slides  
4 mounting brackets  
Mounting material

#### ■ How supplied

Flat-packed kit

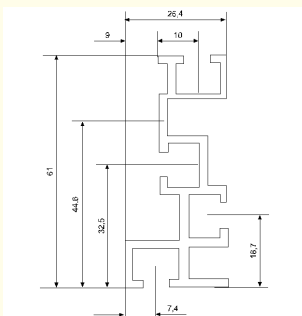

SMA20105

W	H	D	U	d	kg	Model	Order no.	UP
			9				02.111.146.9	1 unit
			12				02.111.147.9	1 unit
			15				02.111.148.9	1 unit
			18				02.111.149.9	1 unit
			21				02.111.150.9	1 unit
			24				02.111.151.9	1 unit



SMA20104

### Knürr Smaract® 19" steel extrusion with mounting holes

- For front and rear installation

#### ■ Material/Finish

19" extrusions: Sheet steel, zinc-passivated  
Mounting bracket: Sheet steel, 1.5 mm,  
zinc-passivated

#### ■ Supply schedule

2 19" extrusions with mounting holes  
4 mounting brackets  
Mounting material

#### ■ How supplied

Flat-packed kit

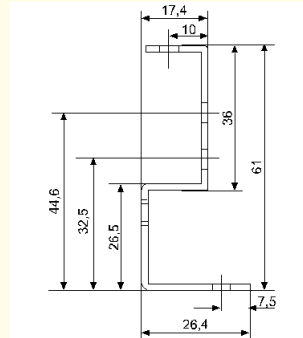

SMA20106

W	H	D	U	d	kg	Model	Order no.	UP
			9				02.111.156.9	1 unit
			12				02.111.157.9	1 unit
			15				02.111.158.9	1 unit
			18				02.111.159.9	1 unit
			21				02.111.160.9	1 unit
			24				02.111.161.9	1 unit

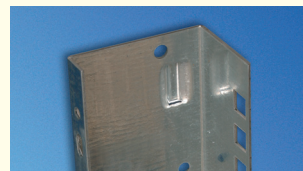

MIR20046

### Knürr Smaract® 19" sheet steel server extrusion

- For front and rear installation

#### ■ Material/Finish

Sheet steel, 0.10 in, zinc-passivated

#### ■ Supply schedule

2 19" extrusions with mounting holes  
Mounting material

#### ■ How supplied

Flat-packed kit

#### ■ Note

Please also order mounting adapter  
01.127.119.9 (set with 4 adapters)

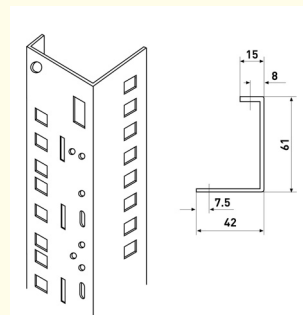

MIR20041

W	H	D	U	d	kg	Model	Order no.	UP
			9				02.111.136.9	1 unit
			12				02.111.137.9	1 unit
			15				02.111.138.9	1 unit
			18				02.111.139.9	1 unit
			21				02.111.140.9	1 unit
			24				02.111.141.9	1 unit

Dimensions in mm: W = Width  
H = Height  
D = Depth  
h = installation height  
d = useful depth  
L = length  
U = standard height unit  
1 U = 44.45 mm  
UP = unit of packaging  
kg = weight  
Express item

Conversion: 1 mm = 0.03937 inch 1 kg = 2.2046 pound

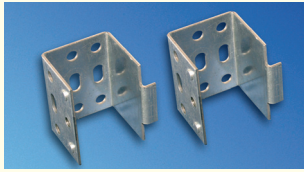

MIR20044

## Mounting adapters for 19" server extrusion

- For mounting Knürr standard components (storage shelves, drawers, chassis runners, keyboard runners, etc.) in 19" installation space

**Material/Finish**  
Sheet steel, zinc-passivated

**Supply schedule**  
4 adapters

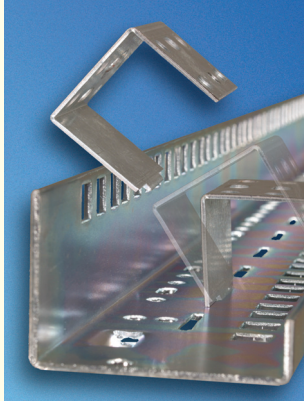

MIR20082

W	H	D	U	d	kg	Model	Order no.	UP
			1				01.127.119.9	1 unit

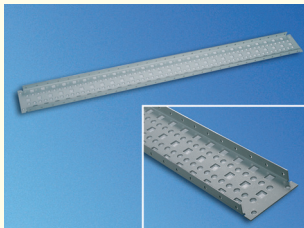

SMA20172

## Knürr Smaract® Depth Brace

- For additional strengthening of the enclosure.
- For routing cables with cable ties and as universal mounting option
- With holes for mounting caged nuts
- Variable positioning with T-slot
- Installation on the frame extrusions

**Material/Finish**  
Sheet steel, 1.5 mm, zinc-passivated

**Supply schedule**  
1 depth brace  
Mounting material

**How supplied**  
Flat-packed kit

**Note**  
Use with 19" server extrusions is not possible

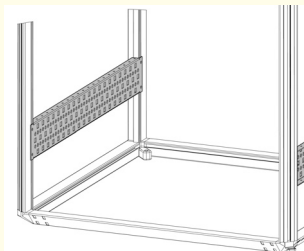

SMA20173

W	H	D	U	d	kg	Model	Order no.	UP
		600					02.111.002.0	1 unit
		800					02.111.004.0	1 unit
		900					02.111.005.0	1 unit

**Dimensions in mm:** W = Width, H = Height, D = Depth, h = installation height, d = useful depth, L = length, U = standard height unit, 1 U = 44.45 mm, UP = unit of packaging, kg = weight, = Express item

**Conversion:** 1 mm = 0.03937 inch, 1 kg = 2.2046 pound



SMA20031

## Knürr Smaract® Door closed

- Can be used as front and rear door

**Supply schedule**  
1 rear panel, closed  
Mounting material

**Material/Finish**  
Sheet steel, powder-coated texture

**How supplied**  
Flat-packed kit

**Color**  
RAL 7035 light gray

W	H	D	U	d	kg	Model	Order no.	UP
			9				02.111.076.1	1 unit
			12				02.111.077.1	1 unit
			15				02.111.078.1	1 unit
			18				02.111.079.1	1 unit
			21				02.111.080.1	1 unit
			24				02.111.081.1	1 unit

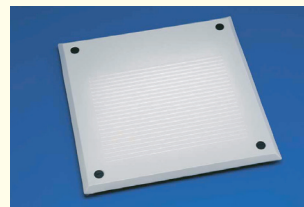

SMA20028

## Knürr Smaract® Top Cover/Bottom Cover closed

**Material/Finish**  
Sheet steel, powder-coated texture

**Color**  
**Final digit of order number .1:**  
RAL 7035 light gray  
**Final digit of order number .8:**  
RAL 7021 dark gray

**Supply schedule**  
1 bottom cover, closed  
Mounting material

**How supplied**  
Flat-packed kit

**Note**  
Use of the bottom cover in combination with the stationary plinth is not possible

W	H	D	U	d	kg	Model	Order no.	UP
600		600					02.111.052.1	1 unit
600		800					02.111.054.1	1 unit
600		900					02.111.055.1	1 unit
600		900					02.111.055.8	1 unit
600		1000					02.111.056.1	1 unit
600		1000					02.111.056.8	1 unit



SMA20168

## Knürr Smaract® Top Cover/Bottom Cover with cable entry

- With integrated cable clamping
- With brush strip for cable entry

**Material/Finish**  
Sheet steel, powder-coated texture

**Color**  
**Final digit of order number .1:**  
RAL 7035 light gray  
**Final digit of order number .8:**  
RAL 7021 dark gray



- **Supply schedule**  
1 bottom cover with cable routing  
1 brush strip  
Mounting material

- **How supplied**  
Flat-packed kit

W	H	D	U	d	kg	Model	Order no.	UP
600		600					02.111.042.1	1 unit
600		800					02.111.044.1	1 unit
600		900					02.111.045.1	1 unit
600		900					02.111.045.8	1 unit
600		1000					02.111.046.1	1 unit
600		1000					02.111.046.8	1 unit

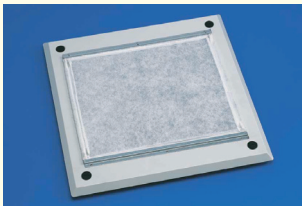

## Knürr Smaract® Bottom Cover, perforated With filter mat

- For cooling with air convection

- **Material/Finish**  
Bottom cover: Sheet steel, powder-coated texture  
Filter mat: Filedon

- **Color**  
RAL 7035 light gray

- **Supply schedule**  
1 perforated bottom cover with filter mat  
Mounting material

- **How supplied**  
Flat-packed kit

W	H	D	U	d	kg	Model	Order no.	UP
600		600					02.111.062.1	1 unit
600		800					02.111.064.1	1 unit
600		900					02.111.065.1	1 unit

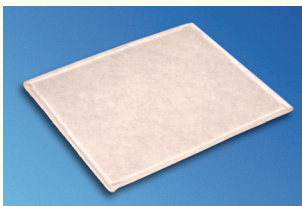

## Knürr Smaract® Replacement Filter Mat For Smaract perforated bottom cover

- For use in conjunction with perforated bottom cover

- **Material**  
Filedon

- **Supply schedule**  
5 replacement filters

- **How supplied**  
Flat-packed kit

W	H	D	U	d	kg	Model	Order no.	UP
						For D600	02.111.068.9	5 units
						For D800	02.111.069.9	5 units
						For D900	02.111.069.9	5 units

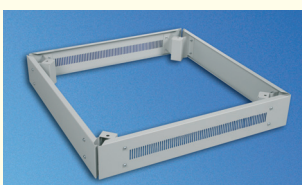

## Knürr Smaract® Plinth

- Cable entry possible from all sides
- Panels front and rear with vent slots and installation option for filter mat

SMA20177

- **Material/Finish**  
Sheet steel, powder-coated texture

- **Color**  
**Final digit of order number .1:**  
RAL 7035 light gray  
**Final digit of order number .8:**  
RAL 7021 dark gray

- **Supply schedule**  
4 plinth corners  
2 closed panels  
2 panels with vent slots  
Mounting material

- **How supplied**  
Flat-packed kit

W	H	D	U	d	kg	Model	Order no.	UP
600	100	600					02.111.201.1	1 set
600	100	800					02.111.203.1	1 set
600	100	900					02.111.204.1	1 set
600	100	900					02.111.204.8	1 set



## Knürr Smaract® Plinth Panel With cable entry for use in conjunction with the plinth

- For use in conjunction with the plinth

- **Material/Finish**  
Sheet steel, powder-coated texture

- **Supply schedule**  
1 panel with cable entry  
1 brush strip  
Mounting material

- **Color**  
**Final digit of order number .1:**  
RAL 7035 light gray  
**Final digit of order number .8:**  
RAL 7021 dark gray

- **How supplied**  
Flat-packed kit

SMA20098

W	H	D	U	d	kg	Model	Order no.	UP
600	100						02.111.206.1	1 unit
600	100						02.111.206.8	1 unit



## Knürr Smaract® Twin Castor

- Height 50 mm

- **Color**  
RAL 9011, graphite black

- **Load rating**  
400 N per castor  
1200 N max. static total load per rack

- **Supply schedule**  
2 twin castors  
2 fixed castors

- **Standards**  
Castors in accordance with DIN 12530  
Load rating in accordance with DIN 12527

- **How supplied**  
Flat-packed kit

SMA20034

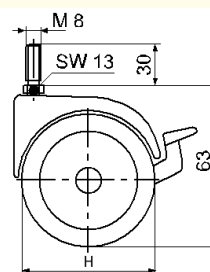

DOP00233

W	H	D	U	d	kg	Model	Order no.	UP
							02.111.175.9	4 unit



SMA20035

## Knürr Smaract® Stacking Set

- Fixed connection for stacking compact racks

**Material/Finish**  
Steel, cold rolled, zinc-passivated

**Supply schedule**  
4 stacking elements  
Mounting material

**How supplied**  
Flat-packed kit

W	H	D	U	d	kg	Model	Order no.	UP
							02.111.171.9	4 unit



MEC00074

## Knürr Smaract® Eyebolt Set

- For hanging on crane hooks
- Load rating, 1900 N static per ring screw

**Material/Finish**  
Tool steel, forged

**Supply schedule**  
4 eyebolts

**How supplied**  
Flat-packed kit

W	H	D	U	d	kg	Model	Order no.	UP
							01.243.440.9	4 unit

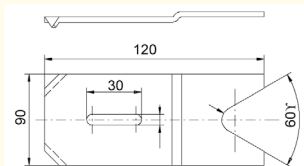

MIR00319

## Base Fixing Kit

**Material**  
Sheet steel, 3.0 mm

**Finish**  
Zinc-passivated

**Supply schedule**  
4 clamping plates

W	H	D	U	d	kg	Model	Order no.	UP
							01.130.934.7	1 unit

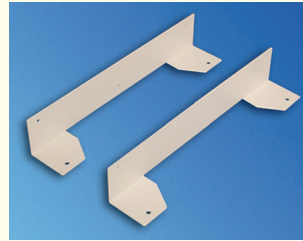

SMA20094

## Knürr Smaract® Wall Mounting Bracket

**Material/Finish**  
Sheet steel, powder-coated texture

**Color**  
RAL 7035 light gray

**Supply schedule**  
2 wall mounting brackets  
Drill hole template  
Mounting material

**Load rating**  
500 N

**How supplied**  
Flat-packed kit

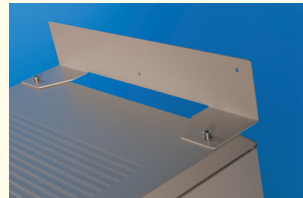

SMA20085

W	H	D	U	d	kg	Model	Order no.	UP
600							02.111.220.9	1 set

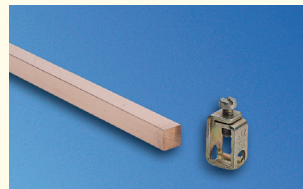

ELM00068

## Earthing Bar

- For safe earthing and equipotential bonding of equipment and installation components

**Material**  
Electrolyte copper, 9x9

**Supply schedule**  
1 earthing bar  
2 brackets  
Mounting material

W	H	S	U	h	d	kg	Model	Order no.	UP
			12					01.110.703.9	1 unit
			15					01.240.543.9	1 unit
			18					01.240.544.9	1 unit
			21					01.240.545.9	1 unit
			24					01.240.546.9	1 unit



DOP20016

## Contact Clamp

- For safe and secure connection of equipment and installation components with the earthing bar
- For cables up to 25 mm<sup>2</sup>

**Supply schedule**  
20 contact clamps

W	H	S	U	h	d	kg	Model	Order no.	UP
								01.110.715.9	20 unit

**Dimensions in mm:** W = Width, H = Height, D = Depth, h = installation height, d = useful depth, L = length, U = standard height unit, 1 U = 44.45 mm, UP = unit of packaging, kg = weight, = Express item

**Conversion:** 1 mm = 0.03937 inch, 1 kg = 2.2046 pound



SMA20035

## Knürr Smaract® 19" Compact Rack, EMC, with sheet steel door

- For components in acc. with IEC 297-3
- Removable covers

■ **Load rating**  
- 2000 N static

■ **Material**  
- Basic rack: Extruded aluminum  
- Covers: Sheet steel  
- EMC spring: Stainless steel

■ **Finish:**  
- Basic rack: polished  
- Covers: Powder-coated texture

■ **Color**  
- RAL 7035 light gray

■ **Supply schedule**  
1 basic rack  
2 side panels, EMC, closed, stop on both sides  
1 top cover, EMC, closed  
1 bottom cover, EMC, closed  
1 front door, EMC, closed, lockable  
1 rear panel, EMC, closed, screwed  
2 19" aluminum vertical extrusions, at the front, with T-slot incl. increment slide  
1 earthing set  
4 leveling feet

■ **How supplied**  
- Assembled

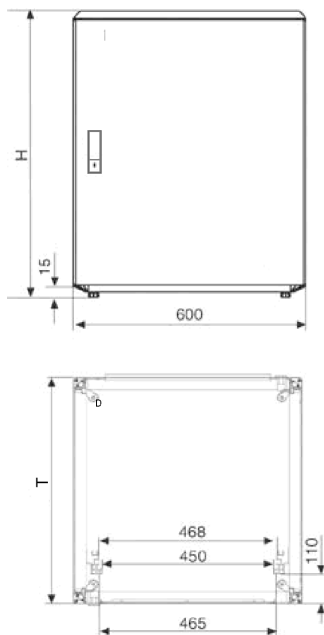

SMA20059

TEC20098

W	H	D	U	h	d	kg	Model	Order no.	UP
600	612	600	12			28		02.110.312.1	1 unit
600	879	600	18			36		02.110.322.1	1 unit
600	1146	600	24			44		02.110.332.1	1 unit
600	612	800	12			32		02.110.314.1	1 unit
600	879	800	18			40		02.110.324.1	1 unit
600	1146	800	24			48		02.110.334.1	1 unit

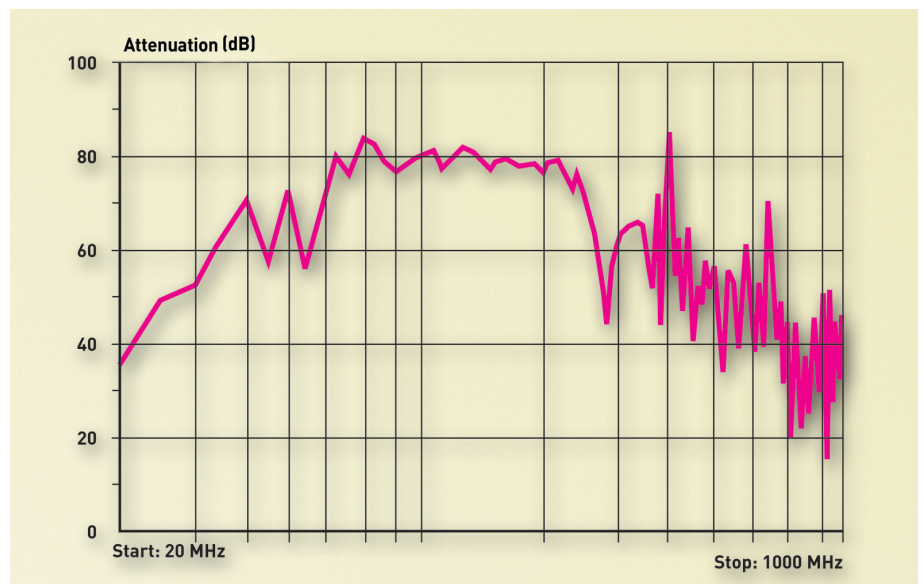

■ EMC measurements performed by pkm Electronic GmbH, Frontenhausen.

■ The tests were carried out in compliance with the following standard: VG 95373 Part 15.

■ Tested rack: width 600, depth 600, height 1150, closed version.

**Dimensions in mm:** W = Width, H = Height, D = Depth, h = installation height, d = useful depth, L = length, U = standard height unit, 1 U = 44.45 mm, UP = unit of packaging, kg = weight,  = Express item

**Conversion:** 1 mm = 0.03937 inch, 1 kg = 2.2046 pound



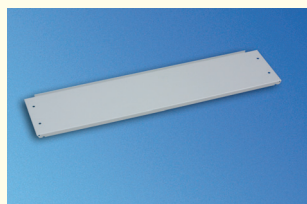

SMA20148

## Knürr Smaract® Connection Panel, EMC, Closed

- EMC shielding
- Screwed

**Material**  
- Cover: Sheet steel  
- EMC spring: High-grade steel

**Finish**  
- Powder-coated texture

**Color**  
- RAL 7035 light gray

**Supply schedule**  
1 connection panel  
2 brackets  
Mounting material

**How supplied**  
- Flat-packed kit



SMA20137

W	H	D	U	h	d	kg	Model	Order no.	UP
600	131.3		3					02.111.351.1	1 set

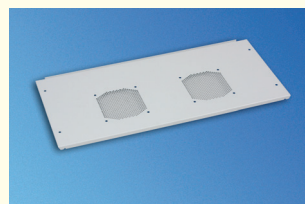

SMA20150

## Knürr Smaract® Connection Panel, EMC, for Fan Unit

- EMC shielding
- Screwed

**Material**  
- Cover: Sheet steel  
- EMC spring: High-grade steel

**Finish**  
- Powder-coated texture

**Color**  
- RAL 7035 light gray

**Supply schedule**  
1 connection panel for fan unit  
2 brackets  
Mounting material

**How supplied**  
- Flat-packed kit

**Note**  
Suitable fan unit: 02.111.180.9

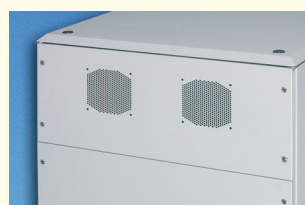

SMA20135

W	H	D	U	h	d	kg	Model	Order no.	UP
600	264.6		6					02.111.372.1	1 set



SMA20145

## Knürr Smaract® Connection Panel, EMC, with Cable Entry

- EMC shielding
- Screwed

**Material**  
- Cover: Sheet steel  
- EMC spring: High-grade steel  
- EMC seal extrusion: Rubber with high-grade steel grid

**Finish**  
- Powder-coated texture

**Color**  
- RAL 7035 light gray

**Supply schedule**  
1 connection panel with cable entry  
2 brackets  
Mounting material

**How supplied**  
- Flat-packed kit



SMA20137

W	H	D	U	h	d	kg	Model	Order no.	UP
600	131.3		3					02.111.361.1	1 set



SMA20152

## Knürr Smaract® Rear Panel, EMC, closed

- EMC shielding
- Screwed

**Material**  
- Cover: Sheet steel  
- EMC spring: High-grade steel

**Finish**  
- Powder-coated texture

**Color**  
- RAL 7035 light gray

**Supply schedule**  
1 connection panel  
2 brackets  
Mounting material

**How supplied**  
- Flat-packed kit



SMA20137

W	H	D	U	h	d	kg	Model	Order no.	UP
600	422.9		9					02.111.353.1	1 set
600	556.3		12					02.111.354.1	1 set
600	689.6		15					02.111.355.1	1 set

Dimensions in mm: W = Width; H = Height; D = Depth; h = installation height; d = useful depth; kg = weight; U = standard height unit; HP = Horizontal pitch; UP = unit of packaging; ESD = ESD version;  = Express item



SMA20062

## Knürr Smaract® 19" Compact Rack IP54 with glass door

- For components in acc. with IEC 297-3
- Removable covers

**Load rating**  
- 2000 N static

**Protection rating**  
- IP 54

**Material**  
- Basic rack: Extruded aluminum  
- Covers: Sheet steel  
- Foam seal: Polyurethane

**Finish:**  
- Basic rack: polished  
- Covers: Powder-coated texture

**Color**  
- RAL 7035 light gray

**Supply schedule**  
1 basic rack  
2 side panels, IP 54, closed, stop on both sides  
1 top cover, IP 54, closed  
1 bottom cover, IP 54, closed  
1 glass front door IP 54, lockable  
1 rear panel, IP 54, closed, screwed  
2 19" aluminum vertical extrusions, at the front, with T-slot incl. increment slide  
1 earthing set  
4 leveling feet

**How supplied**  
- Assembled

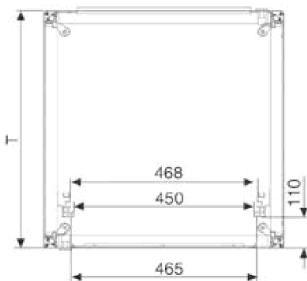
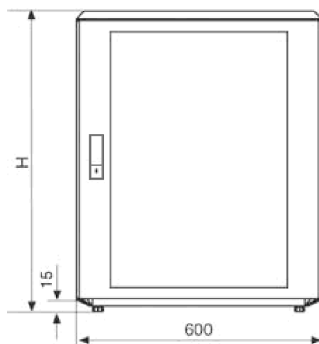

SMA20108

W	H	D	U	h	d	kg	Model	Order no.	UP
600	612	600	12			28		02.110.212.1	1 unit
600	879	600	18			36		02.110.222.1	1 unit
600	1146	600	24			44		02.110.232.1	1 unit
600	612	800	12			32		02.110.214.1	1 unit
600	879	800	18			40		02.110.224.1	1 unit
600	1146	800	24			48		02.110.234.1	1 unit

Dimensions in mm: W = Width: U = standard height unit  
 H = Height: HP = Horizontal pitch  
 D = Depth: UP = unit of packaging  
 h = installation height: ESD = ESD version  
 d = useful depth:  = Express item  
 kg = weight

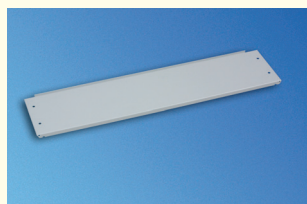

SMA20148

## Knürr Smaract® Connection Panel, IP 54, Closed

- Protection rating, IP 54
- Screwed

**Material**  
- Cover: Sheet steel  
- Foam seal: Polyurethane

**Finish**  
- Powder-coated texture

**Color**  
- RAL 7035 light gray

**Supply schedule**  
1 connection panel  
2 brackets  
Mounting material

**How supplied**  
- Flat-packed kit



SMA20138



SMA20143

## Knürr Smaract® Connection Panel, IP 54, for Fan Unit

- Protection rating, IP 54
- Screwed

**Material**  
- Covers: Sheet steel  
- Foam seal: Polyurethane  
- Exit filter: ABS plastic, UL94 V-0

**Finish**  
- Powder-coated texture

**Color**  
- RAL 7035 light gray

**Supply schedule**  
1 connection panel for fan unit  
2 brackets, mounting material

**How supplied**  
- Flat-packed kit

**Note**  
Suitable fan unit: 02.111.180.9



SMA20136

W	H	D	U	h	d	kg	Model	Order no.	UP
600	131.3		3					02.111.301.1	1 set

W	H	D	U	h	d	kg	Model	Order no.	UP
600	264.6		6					02.111.322.1	1 set



SMA20139

## Knürr Smaract® Connection Panel, IP 54, with Cable Entry

- Possible sealing: IP 54
- Screwed

**Material**  
- Cover: Sheet steel  
- Foam seal: Polyurethane  
- Seal extrusion: Type 1 Sponge rubber seal  
Type 2 Polymeric reinforced with metal

**Finish**  
- Powder-coated texture

**Color**  
- RAL 7035 light gray

**Supply schedule**  
1 connection panel with cable entry  
2 brackets  
Mounting material

**How supplied**  
- Flat-packed kit



SMA20169



SMA20138

W	H	D	U	h	d	kg	Model	Order no.	UP
600	131.3		3				Type 1	02.111.311.1	1 set
600	131.3		3				Type 2	02.111.312.1	1 set



SMA20141

## Knürr Smaract® Rear Panel, IP54, Closed

- Protection rating, IP 54
- Screwed

**Material**  
- Covers: Sheet steel  
- Foam seal: Polyurethane

**Finish**  
- Powder-coated texture

**Color**  
- RAL 7035 light gray

**Supply schedule**  
1 connection panel for fan unit  
2 brackets  
Mounting material

**How supplied**  
- Flat-packed kit



SMA20138

W	H	D	U	h	d	kg	Model	Order no.	UP
600	156.3		3					02.111.308.1	1 set
600	289.6		6					02.111.302.1	1 set
600	422.9		9					02.111.303.1	1 set
600	556.3		12					02.111.304.1	1 set
600	689.6		15					02.111.305.1	1 set
600	823		18					02.111.306.1	1 set
600	956.3		21					02.111.307.1	1 set

Dimensions in mm: W = Width  
H = Height  
D = Depth  
h = installation height  
d = useful depth  
kg = weight

U = standard height unit  
HP = Horizontal pitch  
UP = unit of packaging  
ESD = ESD version

 = Express item